

**SK0200300 Mallard Antenna 6-in-1 Black
incl. 5m Coax Cables - Tetra**



- 6 Functions In 1 Antenna
- ESN Transition Antenna Supporting Tetra
- Ultra-Wide Bandwidth 698MHz – 6000Mhz
- 4x4 MiMo Dual Band WiFi
- Low Profile OEM Styled Shark Fin
- Simple, Single Hole Installation
- GPS/GNSS Port DC Isolated
- CE Directive 2014/53/EU Compliant

Available in white: SK0200360



This 'Mallard' is supplied as a kit with all coax cables to support general SMA connections, mostly suited to vehicle routers, and your existing Tetra Radio as this kit included the correct GPS adaptor cables to support Motorola and Sepura Tetra radios to give a complete transition solution.

With market leading isolation to support ESN, as well as your current Tetra radio, there is no need to fit two antennas to your vehicle. With many fitting kit options available there is no reason to drill unwanted holes to the roof of your car. Contact Sure Antennas for many optional fitting accessories.

Designed as a multi-function antenna, the Mallard supports an ultra-wide bandwidth from 698MHz to 6GHz with a minimum 4dBi gain across the whole band. With the additional functionality of 4x4 MiMo 2.4/5.8GHz WiFi function, a GPS/GNSS port, and Tetra, this antenna would be an ideal solution for future proofing your new vehicle installations for ESN.

With a single hole installation, and so many potential frequency functions on offer, this antenna would help reduce installation costs and protect your vehicles resale value. Available with an option of 3m or 5m low loss coax extension cables all terminated and labelled for ease of installation.

Additional Part Number Options

SK0200302	Mallard Antenna 6-in-1 Black incl. 3m Coax Cables - Tetra
SK0200360	Mallard Antenna 6-in-1 White incl. 5m Coax Cables - Tetra
SK0200362	Mallard Antenna 6-in-1 White incl. 3m Coax Cables - Tetra



Technical Specifications

Electrical Data	TETRA	WiFi
Frequency Range (MHz)	380 - 430 MHz	2.4 GHz & 5.8GHz
Band	TETRA	4x4 MiMo Dual Band WiFi
VSWR	<2.1:1 TYPICALLY 1.5:1	<2.1:1 TYPICALLY 1.5:1
Gain	5dBi	Minimum 4dBi
Isolation	-	<-25dB
Polarisation	Vertical	Vertical
Pattern	Omni-directional	Omni-directional
Impedance	50Ω	50Ω
Max Power Input (W)	25W	10W
GPS/GLONASS		
Frequency Range (MHz)	1562-1612	
VSWR	<2:1	
Gain	26dB	
Polarisation	Right Hand Circular	
Operating Voltage	3-5v DC (fed via coax)	
Cable	2x 230mm RG316 Terminated to SMA (m)	
Mechanical Data		
Dimensions (mm)	H80xW70xL230 *	
Operating Temp (°C)	-40 / +80°C (-40° / 176°F)	
Material	ABS/PC	
Colour	Black	
Weight (g)	310	
Ingress Protection	IP66	
Cable Data		
Cable Type	RG316	RG316
length	280mm	200mm
Diameter	2.8	2.8
Termination	TNC (f)	SMA (m) Reverse Polarity
Mounting Data		
Mounting Type	Panel mount	
Mounting Hole (mm)	15mm	
Max Panel Thickness (mm)	10mm	

Subject to change without prior notice. *Excluding external antenna

**SK0200300 Mallard Antenna 6-in-1 Black
incl. 5m Coax Cables - Tetra**



Supplied Coax Extension Cables

Coax Cables	4x WiFi	1x Tetra	1x GPS
Cable Type	SBC240	SBC195	SBC100
length	5m or 3m	5m or 3m	5m or 3m
Diameter (mm)	6.1	4.95	2.8
Min. Bend Radius (mm)	30	25	14
Operating Temp. °C	-40-80	-40-80	-40-80
Termination	SMA Reverse Polarity (m)	BNC (m)	SMA (m) – Motorola and Sepura adaptors supplied.
Labeling	WiFi M & WiFi A	TETRA	GPS TETRA

Technical Drawing

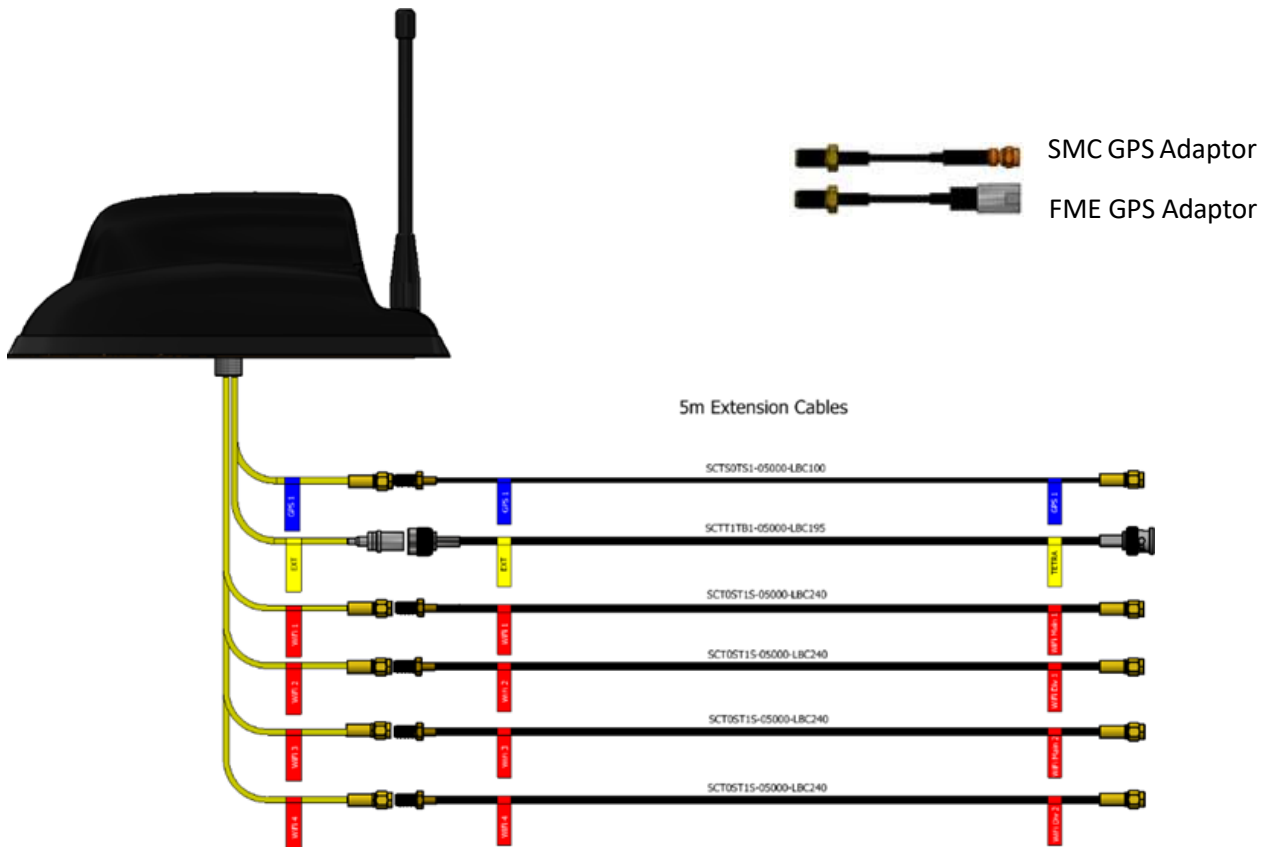

Mallard Antenna Dimensions

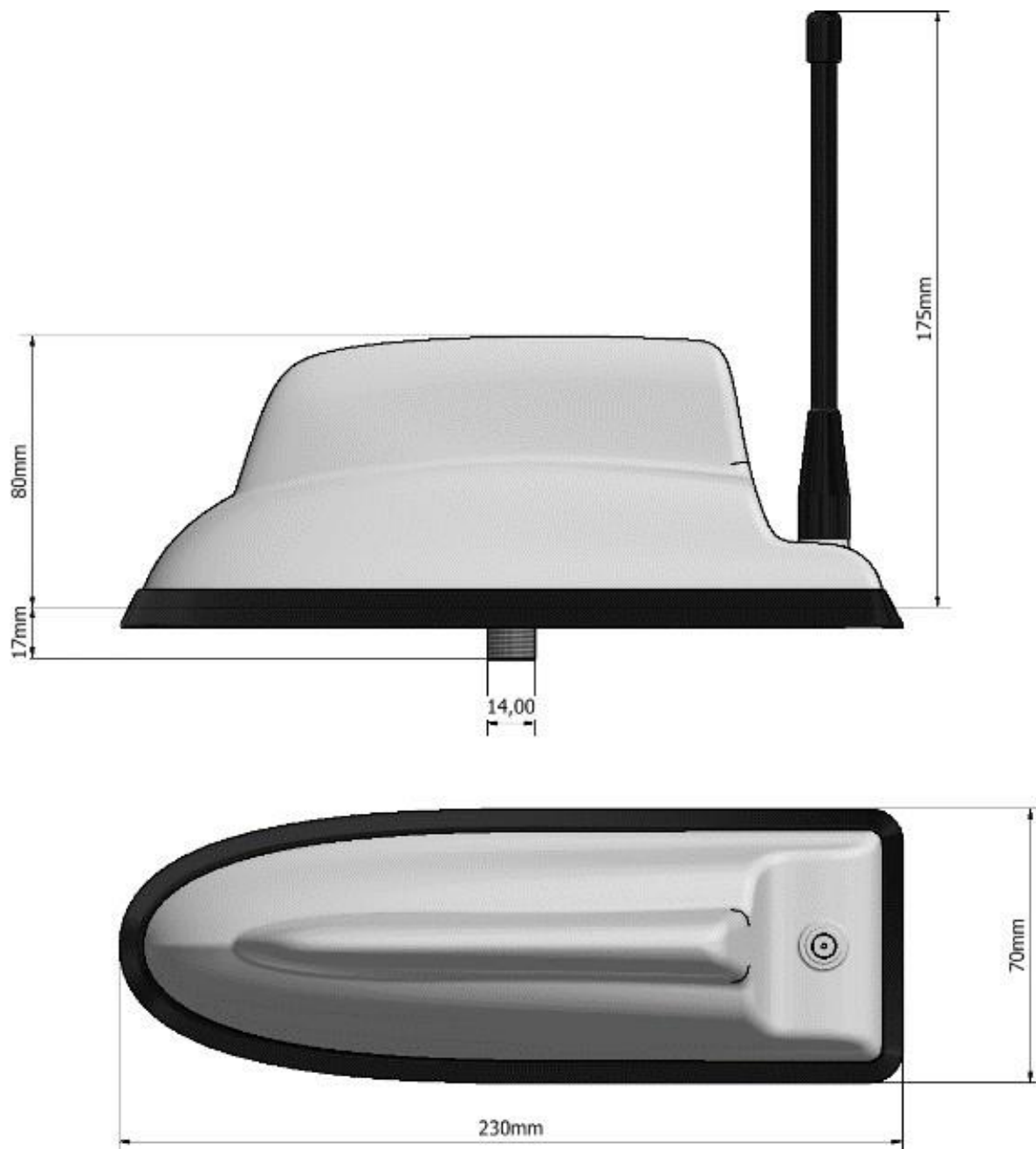

WiFi VSWR Plot

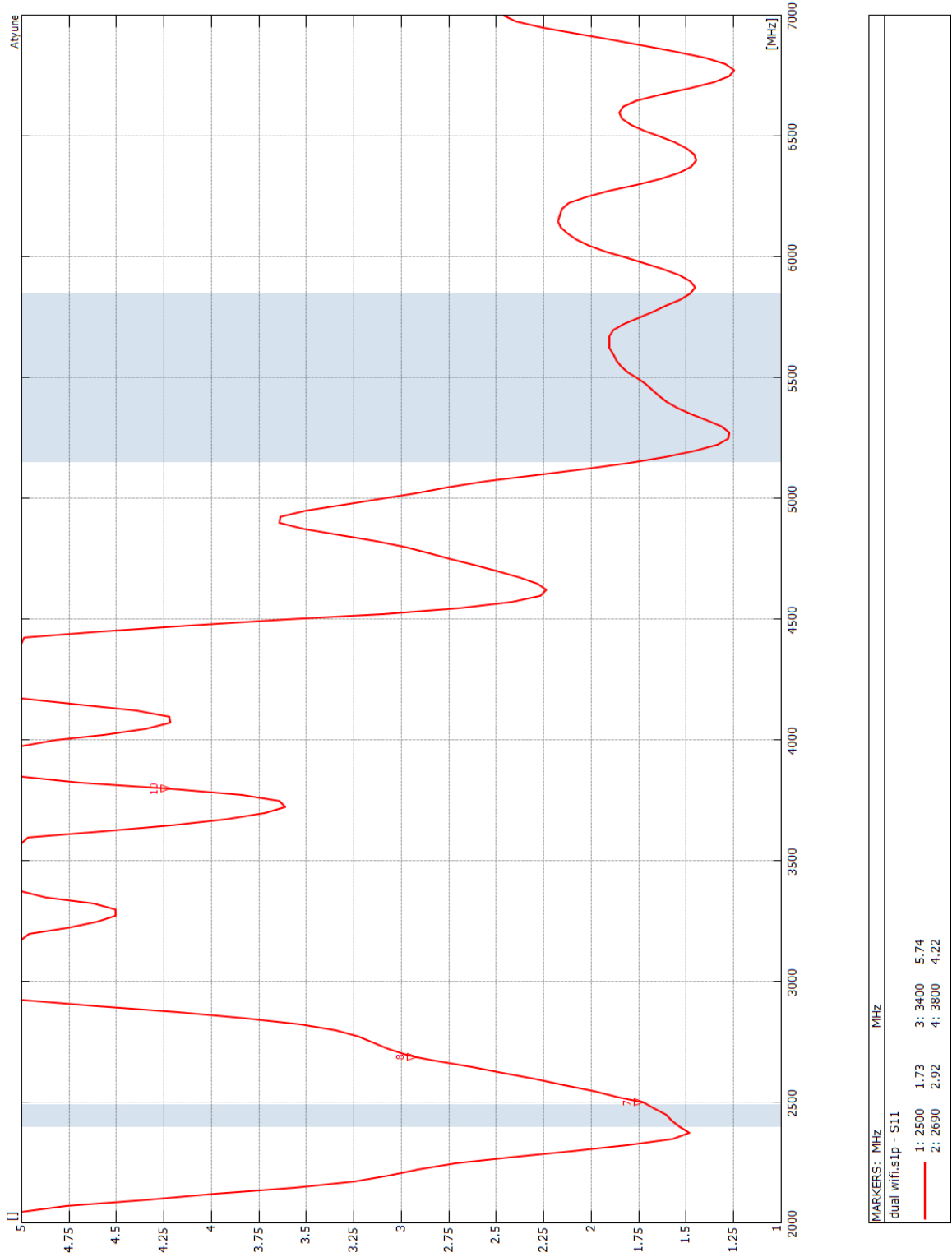

Subject to change without prior notice.

TETRA VSWR Plot

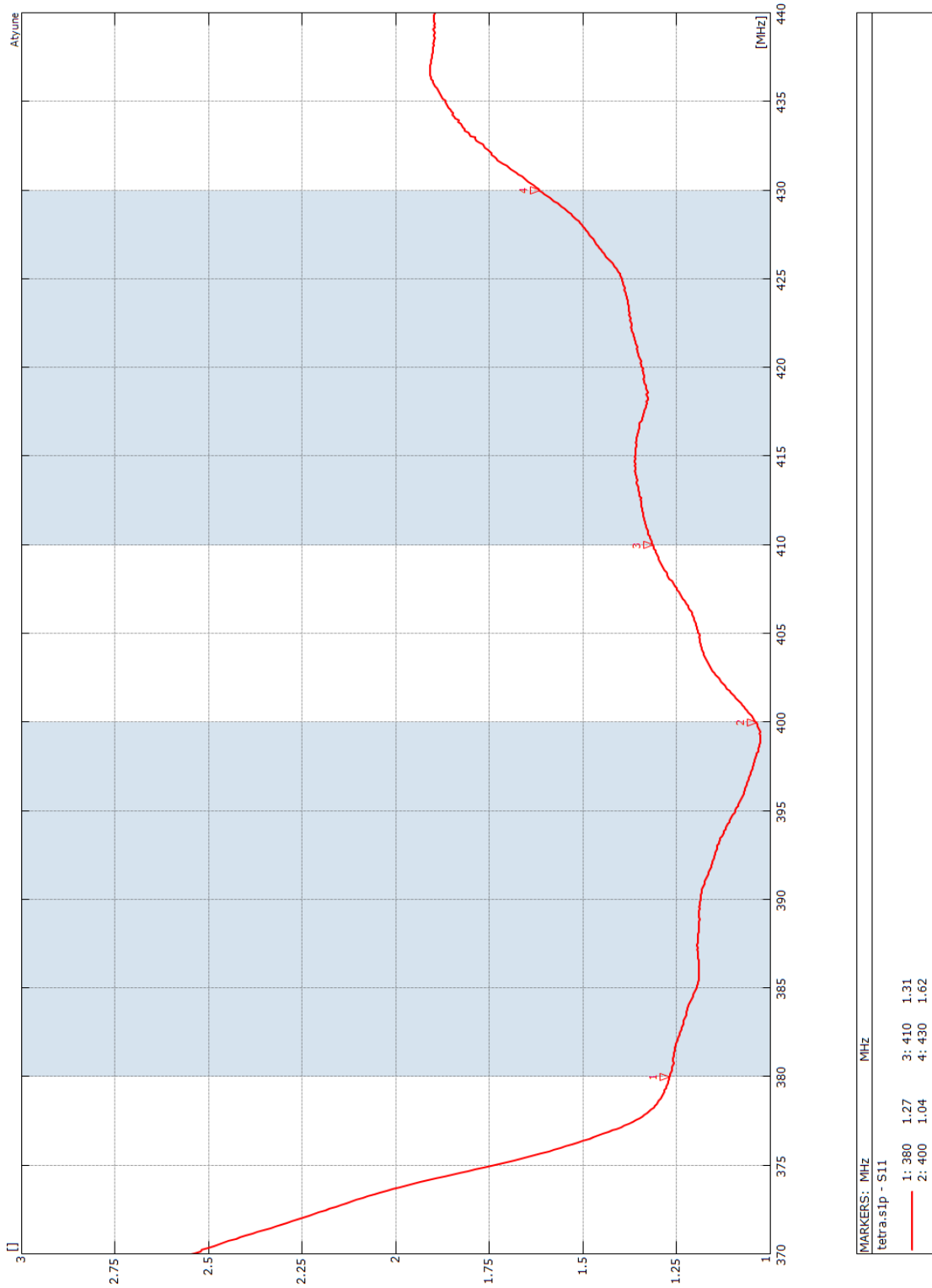

Subject to change without prior notice.

TETRA Isolation

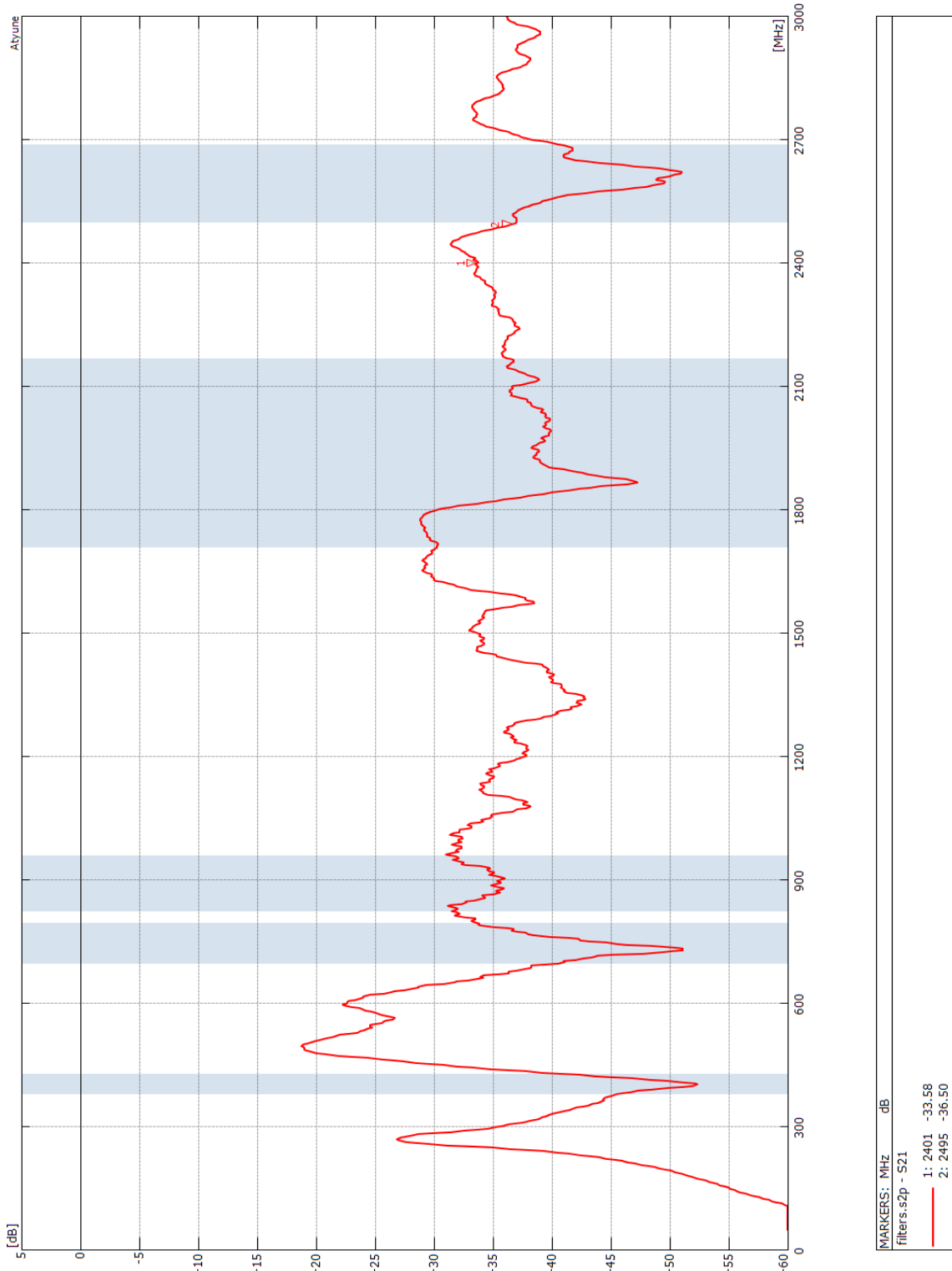

Subject to change without prior notice.

Antenna 3D Gain Plots

0.82 GHz

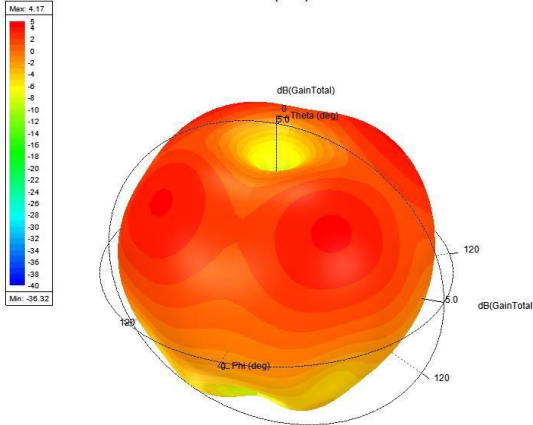

1.82 GHz

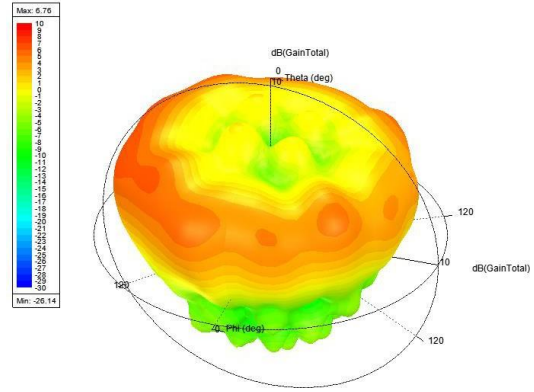

2.14 GHz

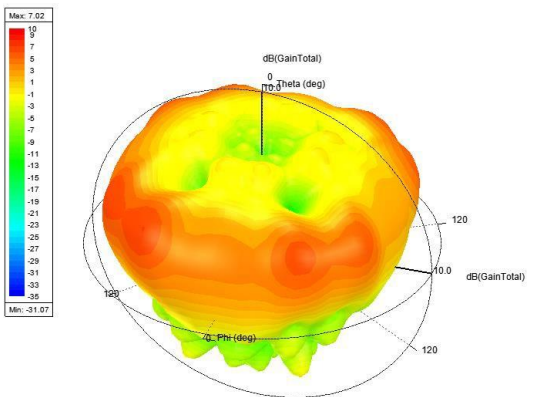

2.6 GHz

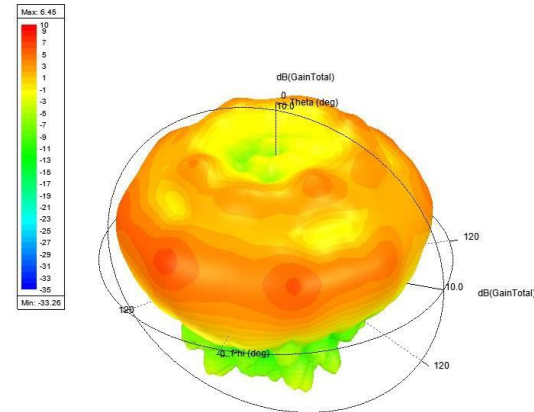

3.6 GHz

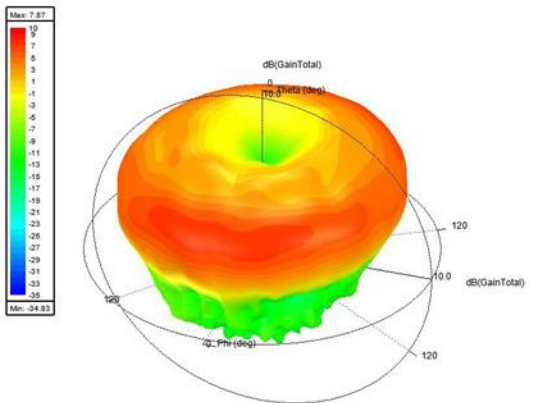









Subject to change without prior notice.

**SK0200300 Mallard Antenna 6-in-1 Black
incl. 5m Coax Cables - Tetra**



Optional Installation Accessories

0250-MP074.01	Mallard Thread Extender M14x1.5	
SK0229200	WiFi Adaptor Cable 500mm Panasonic CF33 Havis Dock RP SMA - TNC	
SK0229202	GPS Adaptor Cable 500mm Panasonic CF33 Havis Dock SMA - TNC	
SK0125500	GPS Adaptor Cable 10mm Handsfree R5 SMA - Blue Fakra	
SK0125501	WiFi/Bluetooth Adaptor Cable 10mm Handsfree R5 RP SMA - Water Blue Fakra	
SCTS0TG0-00100-RG316	GPS Adaptor Cable 10mm Cleartone SMA – GT5	
ST50S0	GPS 50 ohm Terminations : SMA Female	
ST500S	WiFi 50 ohm Terminations : SMA Female RP	
Other optional custom coax cables are available, please contact us for more information.		

